

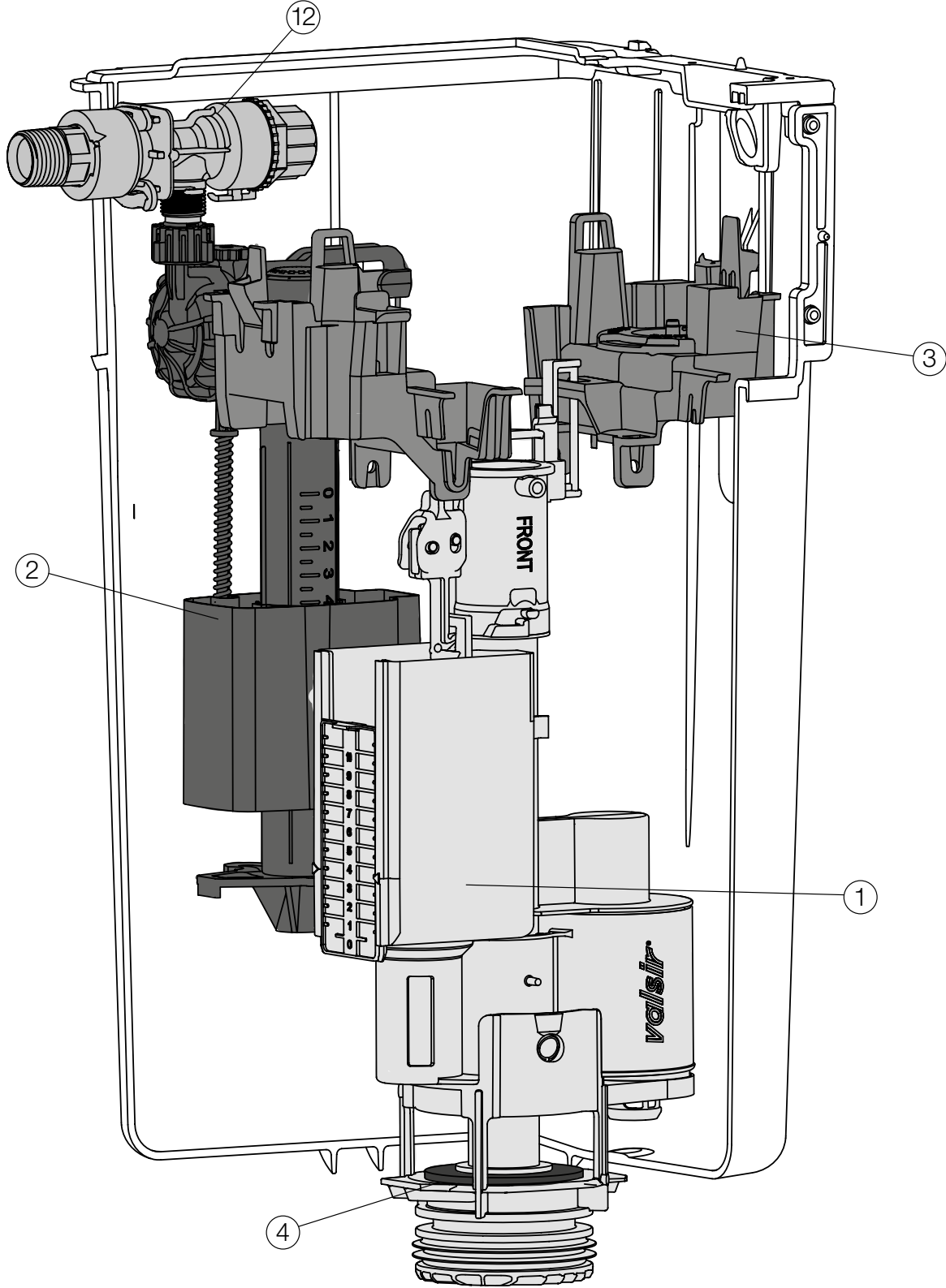







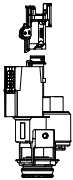
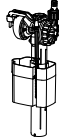
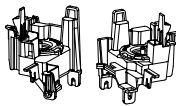

CUBIK S

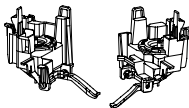
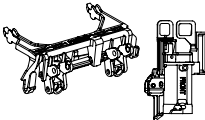
SISTEMI
RISCIAQUO

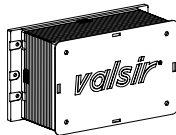

CUBIK S

Ricambi		COD.		CL	€/pz	
①		Valvola per Cubik S meccanica	VS0866890	1	ACCA	32,25
②		Rubinetto galleggiante Compact	VS0866693	1	ACCA	26,68
③		Blocco centrale Cubik S	VS0866894	1	ACCA	11,58
④		Guarnizione per valvola	VS0866603	10	ACCA	1,93
⑤		Kit trasformazione da meccanico a pneumatico Cubik S	VS0866892	1	ACCA	41,79
⑥		Kit trasformazione da pneumatico a meccanico	VS0866896	1	ACCA	21,94
⑧		O-ring per bocchettone (2 pz)	VS0820163	1	ACCA	2,95
⑨		Guarnizione a due labbra per tubo di cacciata	VS0820119	10	ACCA	1,70
⑨		Cassa di protezione	VS0866625	1	ACCA	20,07
⑩		Kit tubo di risciacquo per Cubik S H 880	VS0863565	1	ACCA	16,31
⑪		Kit tubo di risciacquo per Cubik S H 1060	VS0868284	1	ACCA	10,80
 ⑫		Rubinetto d'arresto	VS0863540	1	ACCA	23,50